**Features :**

- High speed switching
- Voltage drive
- Low inductance module structure

Typical Applications:

- Inverter for Motor Drive
- Inverter welding machines
- Uninterruptible Power Supply
- Industrial machines

SYMBOL	CHARACTERISTIC	TEST CONDITIONS	VALUE			UNIT
			Min	Type	Max	
V_{CES}	Collector-Emitter voltage	$T_j=25^\circ\text{C}$			1250	V
V_{GES}	Gate-Emitter voltage	$T_j=25^\circ\text{C}$			± 30	V
I_C	Collector current	Continuous@ $T_C=100^\circ\text{C}$			150	A
I_{CP}		$T_j=25^\circ\text{C}$, 1ms			300	A
P_C	Collector power dissipation	$T_j=150^\circ\text{C}$, 1 device			657	W
T_j	Junction temperature	/			175	$^\circ\text{C}$
T_{stg}	Storage temperature	/	-40		125	$^\circ\text{C}$
V_{iso}	Isolation between terminal and copper base	$T_j=25^\circ\text{C}$, AC: 1minute	2500			V
Screw torque	Mounting(M6)	/	4.5		6.0	N·m
	Terminals(M6)	/	4.5		6.0	N·m
I_{CES}	Zero gate voltage collector current	$T_j=25^\circ\text{C}$, $V_{CE}=1200\text{V}$, $V_{GE}=0\text{V}$			1.0	mA
I_{GES}	Gate-Emitter leakage current	$T_j=25^\circ\text{C}$, $V_{CE}=0\text{V}$, $V_{GE}=\pm 20\text{V}$			± 2	μA
$V_{GE(th)}$	Gate-Emitter threshold voltage	$T_j=25^\circ\text{C}$, $V_{CE}=20\text{V}$, $I_C=150\text{mA}$	4.5		8.5	V
$V_{CE(sat)}$	Collector-Emitter saturation voltage	$T_j=25^\circ\text{C}$, $V_{GE}=15\text{V}$, $I_C=150\text{A}$		1.80	2.40	V
		$T_j=125^\circ\text{C}$, $V_{GE}=15\text{V}$, $I_C=150\text{A}$		1.95		V
		$T_j=150^\circ\text{C}$, $V_{GE}=15\text{V}$, $I_C=150\text{A}$		2.25		V
C_{ies}	Input capacitance	$T_j=25^\circ\text{C}$, $V_{CE}=10\text{V}$, $V_{GE}=0\text{V}$, $f=1\text{MHz}$		12.6		nF
t_{on}	Turn-on time	$T_j=150^\circ\text{C}$, $V_{CC}=600\text{V}$, $I_C=150\text{A}$, $V_{GE}=\pm 15\text{V}$, $R_G=6.8\Omega$, Inductive load		160		ns
t_r				50		ns
t_{off}	Turn-off time			680		ns
t_f				250		ns
t_{sc}	Short circuit withstand time	$T_j=150^\circ\text{C}$, $V_{CC}=720\text{V}$, $V_{GE}=\pm 15\text{V}$, $R_G=6.8\Omega$	10			μs
V_F	Forward on voltage	$T_j=25^\circ\text{C}$, $I_F=150\text{A}$		2.10	2.60	V
		$T_j=125^\circ\text{C}$, $I_F=150\text{A}$		2.00		V
		$T_j=150^\circ\text{C}$, $I_F=150\text{A}$		1.90		V
t_{rr}	Reverse recovery time	$T_j=125^\circ\text{C}$, $I_F=150\text{A}$		150		ns
		$T_j=150^\circ\text{C}$, $I_F=150\text{A}$		160		ns
$R_{th(j-c)}$	Thermal resistance(per chip)	IGBT			0.19	$^\circ\text{C/W}$
		FWD			0.28	$^\circ\text{C/W}$
$R_{th(c-f)}$	Contact thermal resistance (per module)	With thermal compound		0.01		$^\circ\text{C/W}$
W_t	Weight				310	g
Outline		454H3				

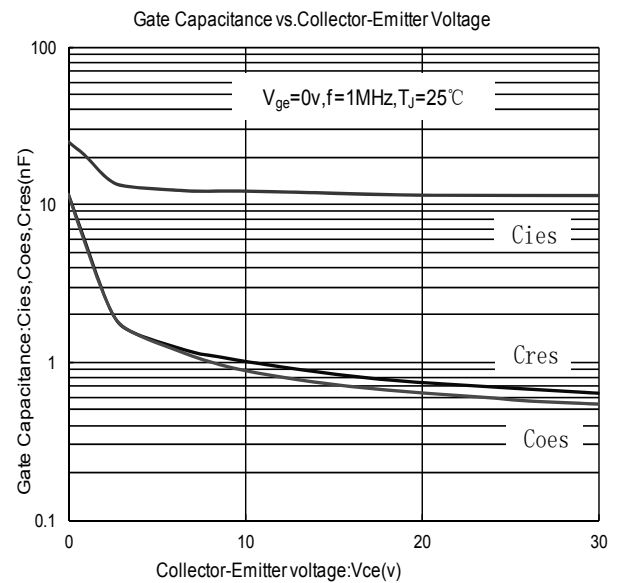
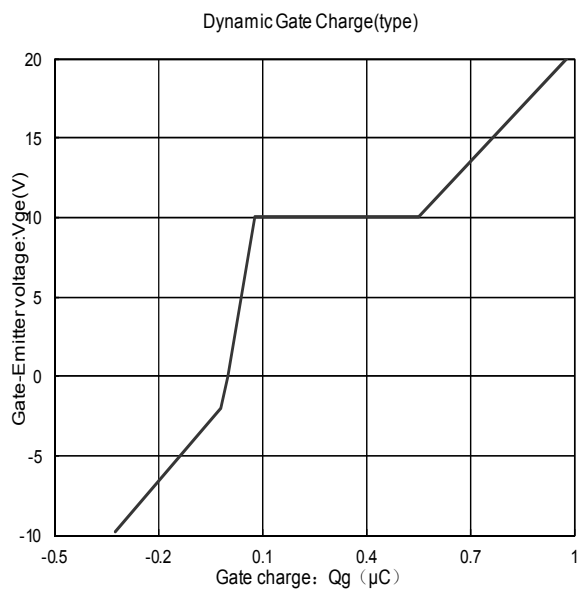
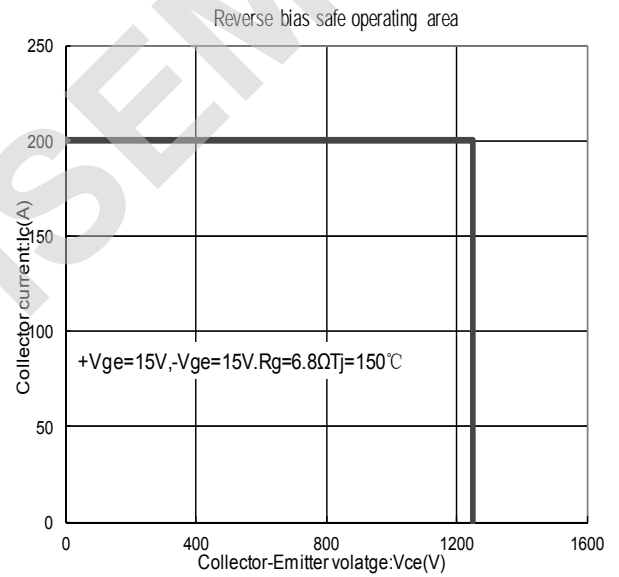
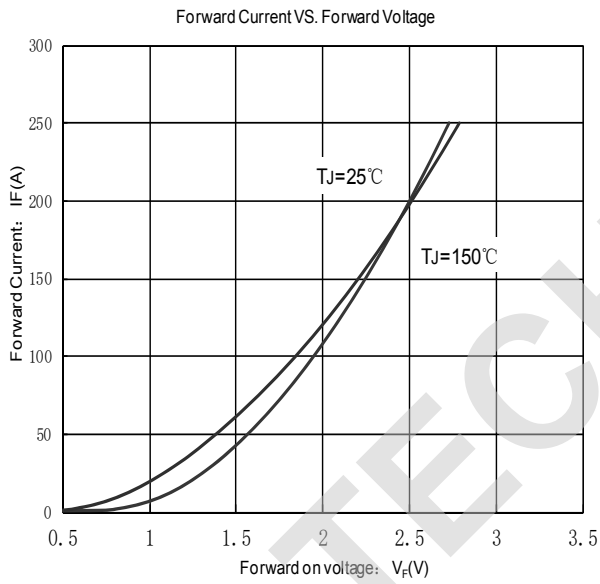
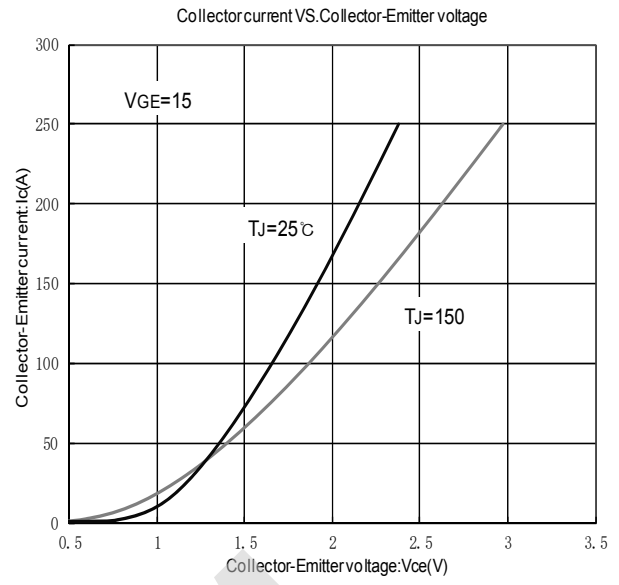
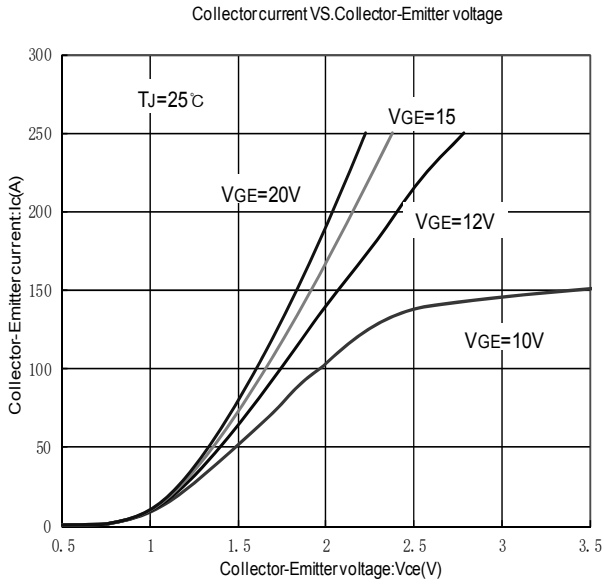

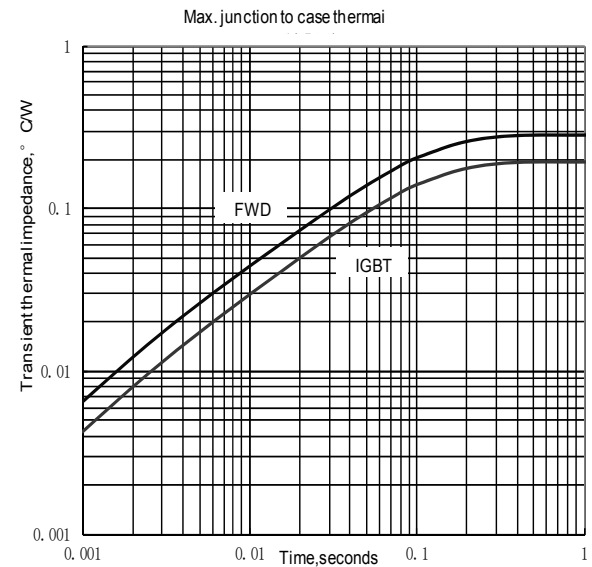
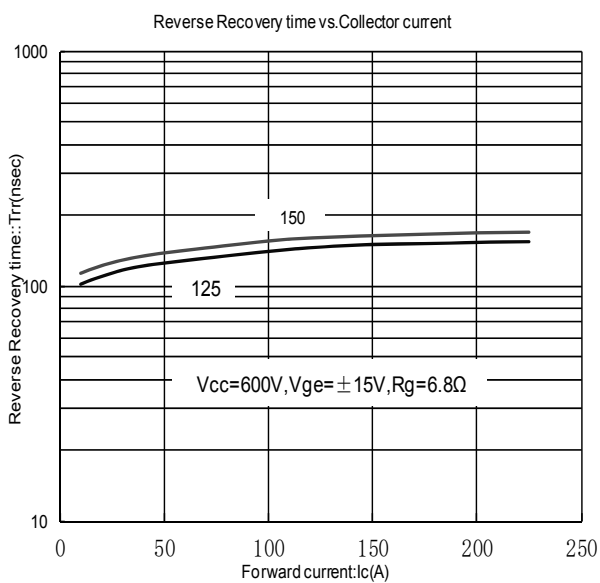
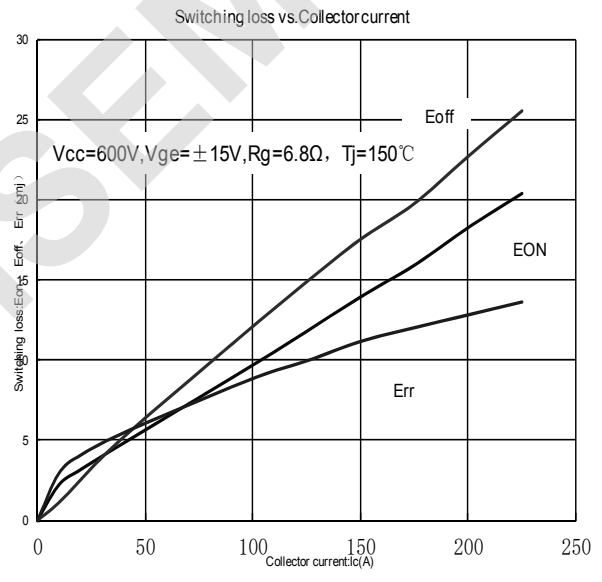
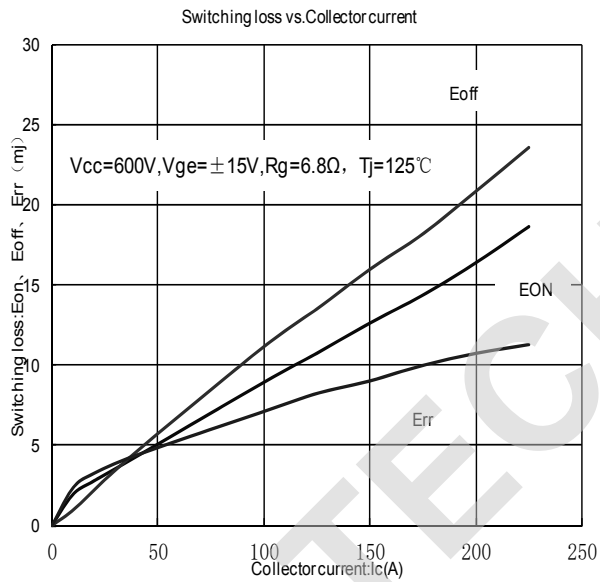
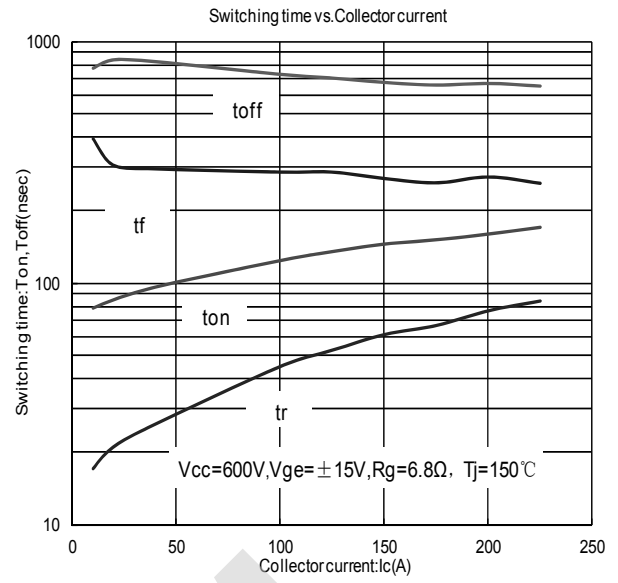
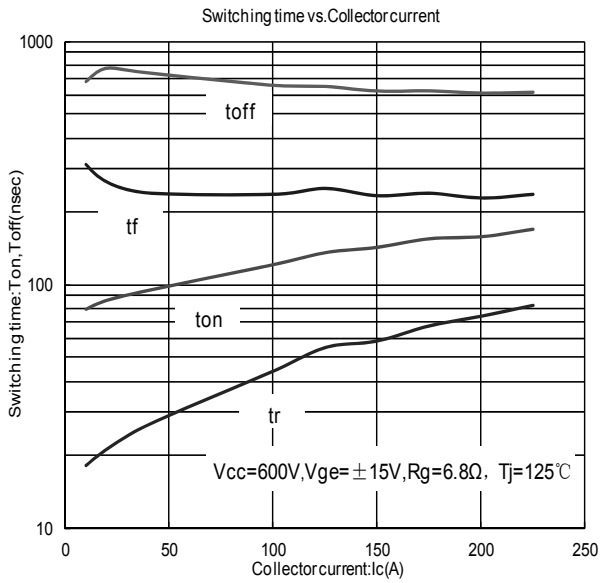

Outline & Circuit Diagram

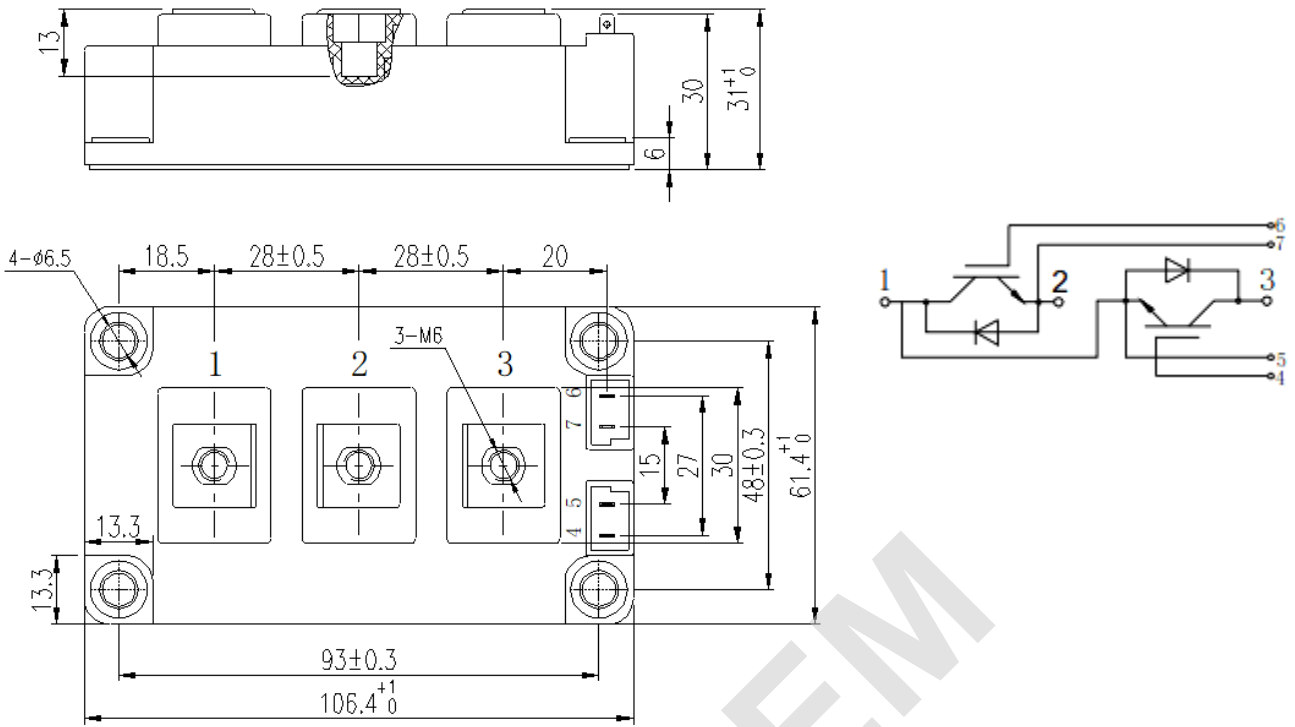

Unmarked dimensional tolerance: \pm 0.5mm

